

Ready At Any Time – An Overview of Pneumatic Cylinders from Rexroth





Everything you need

Today's cylinders must be perfect in every detail and be able to communicate in a variety of ways. Excellently equipped, both outside and inside: From the broad range of electronic and pneumatic connection technologies through the safe and precisely-controlled movements right up to reliable and exact sensors.

Competent and well-designed down to the last detail – application-oriented cylinder technology from Rexroth

Our customers are demanding. They expect the highest performance from us and our solutions. And that is exactly what we want – because what our customers expect of us is what we expect of ourselves. That applies to all our services, as well as to every single element in our product range – right down to the last detail.

Perfection is our business

Our comprehensive range of perfected cylinder technology meets the demands of modern automation technology and offers suitable solutions for all applications, with all components reflecting our product philosophy of consistently high standards in quality and design.

- ▶ Functionality
- ▶ Modularity
- ▶ Quality and design

And whatever we do, the benefit for the customer is the focus of all our work – in advice and support, research and development, design and production. An absolute practice and solution orientation – but with an eye on trendsetting innovations that open up new possibilities. Function integration, component reduction, alternative materials management – those are just a few of the trends in modern product development that create future advantages and additional benefits that you can expect from Rexroth as a global supplier of automation technology.



- ▶ **System expertise**
- ▶ **Long-term product strategy**
- ▶ **Industry management**
- ▶ **International know-how**
- ▶ **Best-in-class components**
- ▶ **Worldwide presence**

The right cylinder solution for every application – perfectly matched to each other

Insight – overview – outlook

This brochure is a fundamental orientation aid for selecting suitable products and provides information on the main features and fields of application of the cylinders. A summary of the program at the end of the brochure serves as an introduction to our detailed catalog.

A comprehensive program with a clear platform strategy

The modern applications for pneumatic cylinders dictate the portfolio. A perfect cylinder has to be not only well designed, easy to integrate, strong, durable and reliable, but also able to function both powerfully and sensitively and able to adapt to a wide variety of demands – it has to prove its high efficiency and cost-effectiveness day after day. Our product range of pneumatic cylinders meets these demands in every respect and is just as versatile as it is comprehensive.

Product group	Mini cylinders	Round cylinders	Short-stroke and compact cylinders	Profile and tie rod cylinders
Size/piston diameter	Ø 2,5 – 32 mm	Ø 25 – 125 mm	Ø 8 – 100 mm	Ø 32 – 320 mm
Industrial standard	ISO 6432		ISO 21287	ISO 15552
Series	<p>OCT ISO</p>  <p>MNI ISO</p>  <p>131</p>  <p>ICM ISO</p> 	<p>ICS</p>  <p>CPC</p> 	<p>CCI ISO</p>  <p>KHZ</p> 	<p>PRA ISO</p>  <p>TRB ISO</p>  <p>ITS ISO</p>  <p>ICL ISO</p>  <p>Cylinder valve unit CVI ISO</p> 
	Pages 6 – 7	Pages 8 – 9	Pages 10 – 11	Pages 12 – 13



















With all options for specific tasks

The spectrum ranges from extremely compact cylinders for small handling applications to larger cylinders for the most powerful tasks, as well as rodless cylinders with guide slides for long strokes right up to ISO cylinders with a clean design.

- ▶ Cylinders with piston rods
- ▶ Rodless cylinders
- ▶ Handling technology

Application-oriented solutions

We are continuously expanding our range of products to cover more tasks and applications in practice. The experience from our day-to-day cooperation with users is fed back directly into our world of products. We are also known as the specialist for customized solutions tailored to specific applications.

Rodless cylinders	Handling technology		Special cylinders	Accessories
Ø 16 – 80 mm	Ø 6 – 25 mm		Ø 6 – 250 mm	
<p>RTC</p>  <p>GSU</p>  <p>CKP</p> 	<p>GPC</p>  <p>MSC</p>  <p>ZSC</p>  <p>GSP</p> 	<p>TWC</p>  <p>MSN</p>  <p>RCM</p> 	<p>SWN</p>  <p>RDC</p>  <p>BCP</p>  <p>BCR</p>  <p>BRB</p> 	<p>ISO 15552/ISO 8139</p> <p>Function units and shock absorbers</p>  <p>Cylinder and piston rod mountings</p>  <p>Sensors and accessories</p>  <p>VTM</p> 
Pages 14 – 15	Pages 16 – 17		Pages 18 – 19	Pages 20 – 21

The mini range for maxi applications

Don't underestimate us! Our smallest cylinders go to work with extremely compact, integrated power and intelligence – and their range of applications is growing. The ongoing trend towards miniaturization of products and components is creating more and more new fields of application for our little all-rounders.

The ideal cylinders for small handling

The minimized dimensions are not the only reason why our mini cylinders are predestined for small handling applications. Maximum precision and reliability, a demand-driven and exactly regulated power control and light-weight thanks to the use of modern materials and trendsetting function integration provide additional benefits for users in a very wide range of industries.



- ▶ Electronics industry
- ▶ Semiconductor industry
- ▶ Medical technology

Mini cylinders play a significant role in modern handling technology applications and adapt perfectly wherever they are used.

Series	OCT	MNI	131	ICM
Resistance	++	+	+	++
Compactness	++	○	○	++
Variety of versions	++	○	-	○
Friction	+	+	+	+
Configurability	+	+	--	○
Stroke range	++	+	+	+

++ Highly recommended + Recommended ○ Suitable
 - Less suitable -- Not suitable

Mini cylinders from Rexroth – a wide variety of talents

The cylinder series cover the entire spectrum of applications

With a minimum piston rod diameter of 2.5 mm and up to a size of 25 mm, the mini cylinders provide the right components in a vast range of configurations for every conceivable application. The OCT, MNI, 131 and ICM series from our program with their specific characteristics, strengths and properties are designed for special applications and industry solutions. The enormous breadth of the product range and variety of versions enable us to offer our customers inexpensive, application-specific tailored solutions with sophisticated combinations of standard components.

OCT series

The octagonal piston form simplifies anti-rotation locking of the piston rod using stainless steel pins. The choice of materials makes the cylinder extremely resistant to aggressive fluids.

MNI series

Our proven range of cylinders for general machine construction. This design is characterized by its robustness and long service life. A cylinder for users and developers who rely on the greatest efficiency.

131 series

Our smallest cylinder is ideal for moving low loads. An important field of application for the 131 series, for example, is fatigue testing of manually actuated devices such as cell phones or computer keyboards.

ICM series

Mini cylinders from the ICM series offer high corrosion resistance and are a reliable, cost-efficient solution – even in harsh environments. The cylinder tube and piston rod are made of stainless steel, the cylinder covers are fashioned from a high-quality polymer.



OCT series



MNI series



131 series



ICM series

Clean design as standard in Rexroth round cylinders

A completely clean solution without any edges or corners. Exactly the right choice for applications in sensitive environments where even the slightest hygiene risk has to be ruled out. The consistently developed clean design in our round cylinder series predestines it for all applications in wet areas.

A multitude of applications

The right selection of materials and a hygiene-oriented design make our round cylinders the first choice for a large number of applications. These include applications in the food industry, as well as in the pulp and paper industry with aggressive environments and high demands on corrosion protection and heat resistance. Or in the chemical industry, to help prevent contamination.



A basic requirement for hygiene in the food and packaging industry is optimum cleaning of the components.

Series	ICS-D1	ICS-D2	CPC
Easy-to-clean surfaces	++	++	++
Configurability	-	-	+
Corrosion resistance	++	++	○
Temperature range	○	○	++
Diameter range	+	+	○
Flexibility/choice of versions	○	○	++

++ Highly recommended + Recommended ○ Suitable
 - Less suitable -- Not suitable

For wash-down applications in sensitive environments

Acid-resistant or made of stainless steel.

Our two round cylinder series for wash-down applications make it easy for the user to decide on components from Rexroth. A wide choice of design variants and a comprehensive program of accessories with all connection options make all wishes possible. All that remains is to select the right materials, and the application-specific solution is yours.

ICS series

The hygienic design of the ICS with smooth surfaces, interlocking seals and cushioning screws prevents dirt pockets from the outset and guarantees optimum cleaning conditions. The stainless steel cylinders in the ICS series are available in the basic variants D1 made of acid-resistant steel for the highest corrosion protection, and D2 made of stainless steel for standard corrosion protection. The ICS-D1 version is particularly recommended for the food processing sector where components come into or may come into direct contact with food. All types of fluid, right up to aggressive acids, can be easily washed off these hygienically designed round cylinders.

- ▶ Hygienic design prevents dirt pockets
- ▶ Different materials, depending on the application
- ▶ Simple cleaning
- ▶ Wide variety of connection options
- ▶ Wide temperature range, -40°C to +150°C

CPC series

The round cylinders from the CPC series offer a wide variety of connection options. They are easy to clean and resistant to corrosion. Apart from automation functions in the food industry, they are also suitable for use in other branches of industry with wash-down applications where hygiene conditions are not the only key consideration.



ICS series



CPC series

When things get tight, our compacts come out strong

They get very little room to work, but have to move a lot in the tightest spaces. Do a lot with very little – those are the ideal specifications for the use of our miniature power packs. In the strictest sense of the word you can say here: less is more.

Save where you can!

There is always room for compact Rexroth cylinders. Save on installation space and costs during the design phase, because our short-stroke and compact cylinder series make it easy to come up with cost-efficient machine constructions. And all that without having to compromise on precision, reliability and innovative technology.

- ▶ Assembly and handling
- ▶ Automotive industry
- ▶ Printing and paper industry

The products from our sophisticated program are backed by the experience from many years of cooperation with users in our core industries. They help to save without making compromises. The comprehensive program with large stroke ranges and piston diameters makes the use of our cylinder series the logical choice in practically any machine environment.



Series	KHZ	KHZ non rotating	CCI	CCI non rotating
Compactness	++	++	+	+
Variety of versions	○	-	++	-
DIN ISO 21287 standard	--	--	++	++
Diameter range	++	++	++	++
Stroke range	○	○	++	++
Sensor installation	+	+	++	++
Guide properties	○	++	○	++

++ Highly recommended + Recommended ○ Suitable
 - Less suitable -- Not suitable

Short-stroke and compact cylinders from Rexroth

Concentrated power in a minimum of space

With sizes from 8 mm to 100 mm piston diameter in a very wide range of variants, our short-stroke and compact cylinder program is one of the largest and most varied on the market worldwide.

KHZ series

The special short-stroke cylinders in the KHZ series are available from a piston diameter of 8 mm and are ideal for extremely confined installation environments. The wide range of variants ensure simple and reliable machine integration.

- ▶ For strokes from 4 mm
- ▶ Also in a non-rotating variant
- ▶ For applications without solenoids

CCI series

CCI means: innovative, compact construction and an easy-to-clean design. The Internet configurator offers a wide range of variants and design details. For example, non-rotating, with a front plate or in an ATEX version. The CCI is also available in a US version with special threads.

CCI turns the exceptional into the standard

The CCI series meets all the demands of ISO standard 21287 and is characterized by a comprehensive product range with a large number of variants and design details. Continuous sensor grooves on each side of the cylinder are only one example of particularly practice-oriented flexibility. The sensors can be installed quickly and easily on all sides and over the entire stroke range.

- ▶ Standardized sizes and connection dimensions
- ▶ Little play of the piston rod
- ▶ Uncomplicated sensor installation– even with short strokes
- ▶ Low length tolerance, as made from a single profile



KHZ series

KHZ series, non-rotating



CCI series, non-rotating

CCI with sensors



◀ Depending on the piston diameter, CCI cylinders are up to 60% shorter than comparable profile cylinders in accordance with ISO 15552.

Sturdy and reliable – quality for standard applications

Standardized to international norms and with an outstanding profile. Our profile and tie rod cylinders have stood the test of decades of user-oriented practice and have established a firm position in professional pneumatics applications. Sturdy and reliable – and all that worldwide.

Universal solutions in numerous industries

With sizes from 32 mm to 320 mm piston diameter, the profile and tie rod cylinders in these series cover the entire range of applications. Our customers rely on the indestructible quality of our cylinder solutions in machine and system construction with tasks requiring high precision and regulated force, as well as in industries where enormous forces are needed.



Particular areas of application are the automotive, printing, paper, and wood industries.

Cylinder valve units are especially suitable for decentralized applications in large-scale systems.



Series	PRA	TRB	ITS	ICL
Resistance	○	○	+	++
Easy to clean	○	○	○	++
Compactness	++	○	○	+
Variety of versions	+	++	+	○
Configurability	++	++	++	++
Temperature resistance	+	++	++	○

++ Highly recommended + Recommended ○ Suitable
 - Less suitable - - Not suitable

ISO cylinders with tie rods and profiles

The standardized classic

Innumerable design variants and sizes in the different cylinder series make it easy for the user to select the most suitable cylinder solutions for his specific application. The broad range of cylinders allows the cylinders to be specifically chosen, not only on the basis of function and quality, but also under strict cost considerations.

PRA series

The PRA cylinder program is based on a compactly designed profile with integrated sensor grooves. Thanks to incomparable pneumatic cushioning, it is no problem for the PRA cylinders to transform load into speed and strain into control.

TRB series

TRB cylinders are among the most frequently employed cylinders in the process industry, automotive industry, and wood processing industry. The series meets every wish for product variety, durability and adaptability to existing processes.

ITS series

The cylinders in the ITS series are the “big brothers” of the TRB series cylinders. They are always specifically used when extremely large masses are involved that have to be moved efficiently and under control with the familiar ease of operation.

ICL series

This cylinder in clean design is produced specially for packaging applications in the food industry. It is characterized by practical sensor mountings and its hygiene-oriented design that combines simple cleaning with maintenance.



PRA series



TRB series



ITS series



ICL series



Cylinder valve unit CVI

◀ **Typical uses for the CVI series are open/close functions such as flap controls and spool applications.**

Precise guidance, large distances, enormous flexibility – and “Easy-2-Combine”

The ideal shuttle service: operates exactly as required. Quick, direct, without detours and always on time. The rodless cylinder concept impresses with absolute repetitive precision, functions highly dynamically with reliable accuracy and is thereby highly cost-effective.

The basis for numerous handling applications

Thanks to their high functionality and drive force in a minimum of space and the wide range of sizes and design variants, the rodless cylinders and slide units are predestined for use as basic modules in handling technology. The great flexibility of the pneumatic connections and mechanical interfaces facilitates machine design and integration into existing configurations. Perfect function integration and practical details, such as size-optimized connections and

ducts and optimized cushioning systems, are further guarantees of safe and reliable continuous operation. The wide range of design variants with different connection options allow targeted use in automated handling technology in many industries. Here, Rexroth focuses on Easy-2-Combine interfaces that do not require transition plates and thus enable simplified machine designs.



Series	RTC-BV	RTC-CG	RTC-HD	RTC-EG	CKP	GSU
Load capacity	-	+	++	○	++	+
Precision	-	++	++	+	++	++
Easy-2-Combine interface	--	++	++	++	++	++
Maximum strokes	++	○	+	○	+	-
Stroke limitation with shock absorbers	--	++	++	++	++	++

++ Highly recommended + Recommended ○ Suitable
 - Less suitable -- Not suitable

Rodless cylinders and slide units with perfect guidance

Precision and speed for long strokes

The rodless cylinders permit an optimum stroke length in relation to their size. This saves space and facilitates machine design. The application range covers piston diameters from 16 mm to 80 mm and stroke lengths up to 9,900 mm. A wide speed range of 0.05 m/s to 5 m/s can be achieved with extremely high repetitive precision.

RTC series

The compact form and unique properties of the RTC series open up completely new application possibilities. Compared with a round piston, the oval piston can withstand higher loads and torques. Slide and piston as a single unit mean high load capacity and reliability. High load capacity with small cylinder dimensions enables a simplified and compact machine design. The RTC series program is based on four variants with different key strengths. For large loads, very precise movement and positioning and a wide range of speeds. Stroke lengths and porting available in metric and inch.

CKP series

CKP series cylinders are particularly suitable for moving high loads in machine environments with limited space. They are equipped with integrated pneumatic cushioning and ensure extremely precise, sturdy guidance with high repetitive precision.

GSU series

This high-performance slide unit forms a sturdy basis for a large number of handling applications. Stroke length and position can be set variably over the entire length of the slide unit – individually from both sides, further underlining the enormous flexibility for installation. The very low overall height and an option for ventilation and exhaust on one side further expand the integration possibilities.

RTC series



RTC-BV

RTC-CG



RTC-HD

RTC-EG

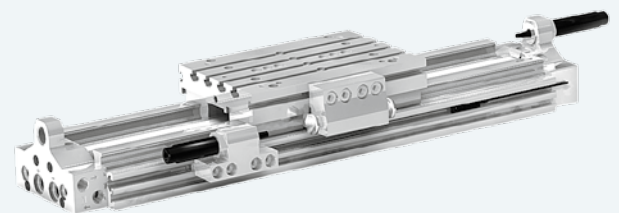

CKP series

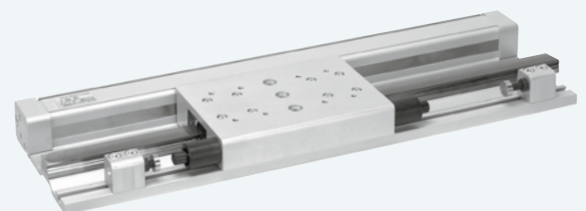

GSU series

We are the guide for handling technology

Gripping, turning and driving – no more, no less. And all from a single source. Rexroth. We not only guide objects and workpieces exactly into their positions with our components and complete solutions – we have also established a leading position for ourselves as providers of handling technology.

Great solutions for small handling

Adequate solutions for practically all conceivable functions in handling technology can be found in Rexroth's comprehensive pneumatics program. Finely-tuned components and elements that perfectly fit together thanks to this consistent product philosophy.

Modularity and ease of installation of the individual components are always key features of our product offerings in addition to pure functionality. Easy-2-Combine with the online configurator – it pays off!

- ▶ Assembly and handling
- ▶ Electronics industry
- ▶ Semiconductor production



In addition to mechanical grippers, rotary modules and guide components, Rexroth also offers the appropriate valve technology for optimum solutions.

Series	GPC	TWC	MSC	MSN	ZSC
Compactness	-	+	○	+	+
Load capacity	○	○	+	-	○
Precision	+	○	++	+	+
Easy-2-Combine	++	-	++	++	+
Cushioning capacity	+	-	++	-	+
Stroke range	+	+	+	-	+
Stroke limitation	-	-	++	--	++

++ Highly recommended + Recommended ○ Suitable
 - Less suitable -- Not suitable

Components for gripping, moving and positioning

Handling technology from a single source

Mechanical grippers, rotary drives and modules, mini slides, guide units, compact and rodless cylinders – the program offers the right components for a full range of applications. Extensive connection and mounting options simplify installation and maintenance. And because everything is so outstandingly matched, design, configuration and machine integration is particularly costeffective.

GPC, TWC series

With a wide range of sizes and minimum space requirements, the GPC and TWC series offer enormous power, sturdiness, and precision while absorbing high torques and transverse forces. GPC impresses in particular through high lateral loads and torsional protection. And TWC deploys the power of a double piston with minimum piston rod play.

MSC, MSN, ZSC series

The mini slides from Rexroth take over a central position and function in a handling module and are responsible for exact short stroke movements. They have a compact design, require little installation space and reliably ensure the necessary dynamics in the system. With three MSC, MSN and ZSC series designed for different applications and with strengths tailored to the respective operating conditions, we can provide the perfect solution for practically every application.

RCM, GSP series

Practically all standardized rotary and swivel movements can be performed with the rotary modules in the RCM series. These modules can be installed directly on mini slides and equipped with the mechanical GSP grippers.



GPC series

TWC series



MSC series

MSN series

ZSC series



RCM series

GSP series

Special cylinders for special applications

The extraordinary has always been something quite normal to us. Under this aspect, components and solutions for specific applications have been developed over decades of user-oriented cooperation with our customers and now form part of our standard program.

Active in all industries

Our customers know that Rexroth is always the right address for standardized solutions for users, no matter whether it's a question of developing or modifying products, finding adequate solutions for new applications or creating alternative solutions that can efficiently replace other technologies in every respect. The Rexroth cylinder program offers an enormous range of standardized solutions for specific applications in practically every industry. The spectrum of components ranges from screw-in cylinders, various flexible diaphragm cylinders and special power transducers right up to the individual series of bellow actuators with totally individual application solutions.

SWN series screw-in cylinders

The cylinders in the SWN series can be easily installed without further accessories. Thanks to a thread integrated directly into the cylinder body, they can be installed in their working environment without taking up space.

RDC series flexible diaphragm cylinders

Thanks to their low friction, the RDC cylinders can be actuated at low pressure. These cylinders permit precise balancing of forces, particularly in finely-tuned systems.



SWN series



RDC series

Solutions with bellow actuators – single, double, triple success

Bellow actuators – high forces at low costs

Rexroth offers five series of bellow actuators. The various designs, equipment, and materials mean that each series is predestined for specific tasks. All bellow actuators permit high forces in small installation spaces. They operate practically without wear or the need for maintenance.

BCP series

The BCP series, the basic variant of the bellow actuators family, has standard bellow material NR/BR and crimped cover plates of galvanized steel with air connections. These bellow actuators are available with single, double, and triple bellows.

BCS series

Bellow actuators from the BCS series are equipped with passivated plates of stainless steel. This cylinder is resistant to corrosion and acids and is thus suitable for use in the food industry, offshore applications, and the pharmaceutical and process industries.

BCE series

In the BCE series, the bellow material is made of the new epichlorohydrin rubber. It ensures optimum temperature resistance and is insensitive to aggressive media, oils, and lubricating greases. These bellow actuators are ideal for applications in the paper industry.

BCR series

The BCR series is equipped with aluminum bead rings without cover plates and is designed for high forces. A perfect match for press technology.

BRB series

Bellow actuators from the BRB series are designed as so-called rolling bellows cylinders, for low forces and short strokes. They are light-weight and offer particularly cost-effective solutions for a variety of applications.



BCP, BCS and BCE series



BCR series



BRB series

The classic fields of application for bellow actuators include:

- ▶ Presses
- ▶ Roller tensioners
- ▶ Tilt devices
- ▶ Tensioning devices
- ▶ Actuation of scissors-type lifting tables and use in vibration isolation as air springs.

The right accessories for all operating conditions and machine environments

They are unimposing but essential. They simply belong there: the right accessories for the job. Rexroth has always attached great importance to having an extensive program of accessories in order to ideally meet the needs of the most varied applications.

We've thought of everything!

Whether it's a secure cylinder mounting, simple piston rod nut, or plain sensor bracket – the importance of these small parts only becomes apparent when they are missing or don't fit. That is no problem for Rexroth customers.

Accessories are an integral part of the scope of supply and have the same high quality as the entire product range.

Practical experience from decades of user-oriented work has also gone into perfecting product accessories. This is

a precondition and guarantee for efficient and generally trouble-free continuous operation of machines and systems.

- ▶ Exactly matched to the product program
- ▶ Mountings complying with ISO standard
- ▶ Best material and manufacturing quality
- ▶ Delivery units configured exactly to the product



Function units and shock absorbers

- ▶ Guide units
- ▶ Piston rod holding units
- ▶ Piston rod locking units
- ▶ Industrial shock absorbers



Cylinder and piston rod mountings

- ▶ Nuts for cylinder and piston rod mountings
- ▶ Foot and flange mountings
- ▶ Clevis mountings, bearing blocks, bolts
- ▶ Intermediate flanges
- ▶ Trunnion mountings
- ▶ Compensating couplings
- ▶ Piston rod extensions
- ▶ Rod clevises, ball eye rod ends

Sensor technology from Rexroth – always alert and responsive

Improved results thanks to optimized sensors

Intelligent sensor technology is a prerequisite for precise, safe cylinder operation. Measurement precision, as well as flexible assembly and adjustable measurement ranges, are essential for meeting a wide variety of requirements. The Rexroth range has the right sensors and accessories for every cylinder.

SM6 series

First-class sensor technology for all cylinders with 6 mm T-groove: With four versions, the distance measuring sensors of the SM6 series flexibly cover all required measuring ranges. The sensors feature easy assembly and infinite adjustment within the respective maximum measurement range, as well as precision and a very high sampling rate.

Sensors and accessories

- ▶ Sensors with cable connection, push-in fitting, M8 plug with knurled screw, contactless, in an ATEX version
- ▶ Sensor solutions for all Rexroth cylinder series
- ▶ Sensor mountings, cable holders
- ▶ Connecting cables, angled connector



SM6 series



Sensors, mountings, connecting cables and plugs



VTM series

VTM series

The right piston speed and correctly adjusted pneumatic cushioning are key factors for optimizing work processes. The VTM time and velocity meter offers a wide array of options to improve cycle times and increase machine performance.

Configure your application online

Use the interactive tools – save time and money

With Rexroth's unique product configurator, you come to a result quickly and easily online. Just describe the intended application and you get a reply within a few seconds showing the proposed cylinder dimensions. The result also includes recommended cylinder speeds and the corresponding valve sizes and hose dimensions. The final result is a complete parts list including, for example, the cylinder switches and fittings. Furthermore, a material number is created that, depending on the user's wishes, represents the product as a kit including assembly parts or as a preassembled unit. For the project documentation, the user receives the relevant documents, the parts list, defined application parameters, calculation results, and complete assembly instructions. CAD data is also supplied. As we said – unique!

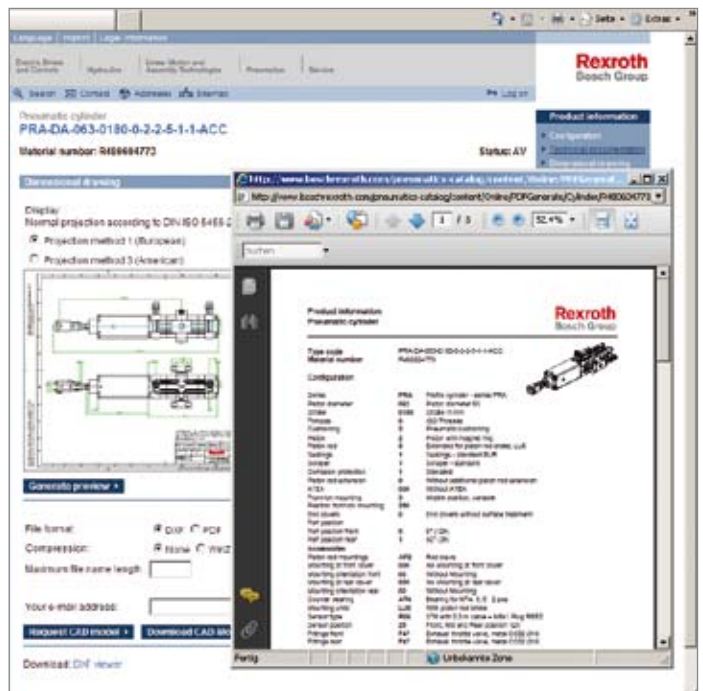
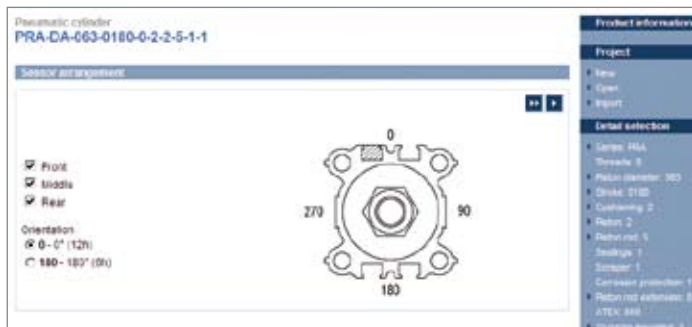
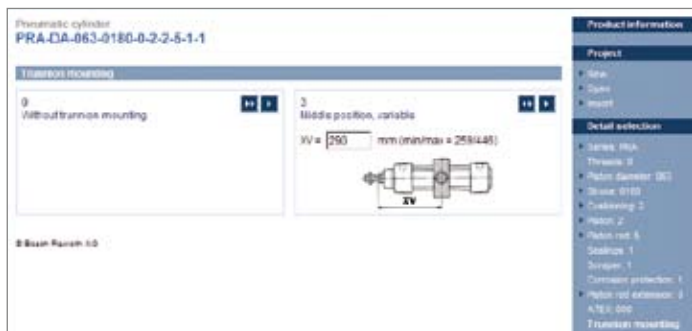
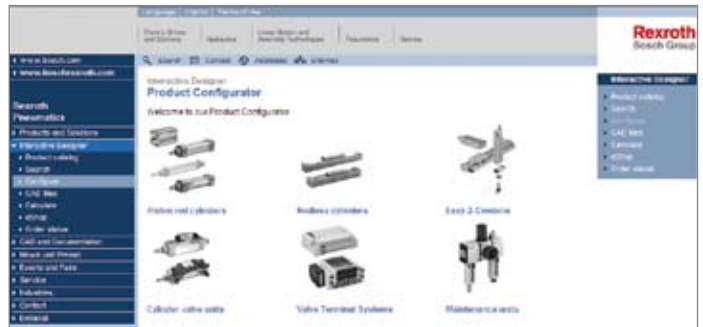

The crucial difference: All-round support until everything is running

We are only satisfied when you are!

Apart from competent advice on the implementation of future-oriented solutions with products of the highest quality, our exemplary support is what customers can also count on. On request, that also includes professional assembly as well as thorough instruction in the operation of the machines and systems until everything is running smoothly.

- ▶ Task analysis and function definition
- ▶ Application-specific configuration
- ▶ Punctual delivery and installation
- ▶ Test run with function optimization

Customized solutions

Our special departments develop customized solutions with functions that are tailored to specific applications. This can include newly designed cylinders or slightly but vitally modified components from the standard cylinder program. Contact our experts! They have know-how from decades of individual design and development work. If there's an individual solution for your application, we'll find it.



Rely on our competence from the outset! From the first discussion, the search for a solution, building of prototypes through the test phases, right up to series production of your individual pneumatics solution.

And the dialog continues

Take advantage of our service – in person or online

We are constantly in direct dialog with our customers and are always a competent contact partner for both technical and economical questions. Despite our comprehensive offering of digital information, personal contact should still be the focus of communication. Through this interaction with the user, we remain close to the action and ensure the technological lead for us and our customers through an open partnership.





























Comprehensive information on the Internet

The Rexroth Internet portal is available round the clock and supports you in all areas of the business process – from design through to the delivery. In the online catalog, you can find further information on the entire product program with all the technical details and use sophisticated design tools.

- ▶ Online catalog
- ▶ Product configuration
- ▶ CAD data
- ▶ Product calculation programs
- ▶ Product query – e-shop

◀ In addition to the various programs, information, and CAD data on offer, you can also check out the corresponding prices and availability of the products and complete your entire order in the e-shop.

Cylinders/handling technology

Diameter		Series	Diameter		Series
2,5 – 10 mm		131	16 – 80 mm		RTC
6 – 16 mm		SWN	16 – 32 mm		CKP
10 – 25 mm		OCT ISO 6432	16 – 25 mm		GSU
10 – 25 mm		MNI ISO 6432	145 – 385 mm		BCP, BCE, BCS
8 – 32 mm		ICM	442 – 950 mm		BCR
32 – 80 mm		CPC	60 – 173 mm		BRB
25 – 125 mm		ICS	6 – 16 mm		MSN
16 – 100 mm		CCI ISO 21287	6 – 25 mm		ZSC
8 – 100 mm		KHZ	8 – 25 mm		MSC
32 – 125 mm		PRA ISO 15552	6 – 32 mm		TWC
160 – 320 mm		ITS ISO 15552	10 – 100 mm		GPC
32 – 125 mm		ICL ISO 15552	0,17 – 6,5 Nm		RCM
32 – 125 mm		TRB ISO 15552	0,11 – 6 Nm		GSP
52,5 – 115 mm		RDC			
32 – 125 mm		CVI ISO 15552			

Bosch Rexroth AG

Pneumatics
Ulmer Straße 4
D - 30880 Laatzen
Phone +49 511 2136-0
Fax +49 511 2136-269
sales-pneumatics@boschrexroth.de
www.boschrexroth.com/pneumatics

Canada

Bosch Rexroth Canada Corp.
3426 Mainway Drive
Burlington, Ontario L7M 1A8
Tel. +1 905 335-5511
Fax +1 905 335-4184

Australia

Bosch Rexroth Pty. Ltd.
3 Valediction Road
Kings Park NSW 2148
Sydney
Tel. +61 2 9831-7788
Fax +61 2 9831-5553

U.S.A.

Bosch Rexroth Corp.
1953 Mercer Road
Lexington, KY 40511-1021
Kentucky
Tel. +1 859 254-8031
Fax +1 859 254-4188

Great Britain

Bosch Rexroth Ltd.
Broadway Lane
South Cerney
Cirencester, GL7 5UH
Gloucestershire
Tel. +44 1285 86-3000
Fax +44 1285 86-3003

Further contacts:

www.boschrexroth.com/addresses

The data specified above only serve to describe the product. No statements concerning a certain condition or suitability for a certain application can be derived from our information. The given information does not release the user from the obligation of own judgement and verification. It must be remembered that our products are subject to a natural process of wear and aging.